

**POWER PACKS**

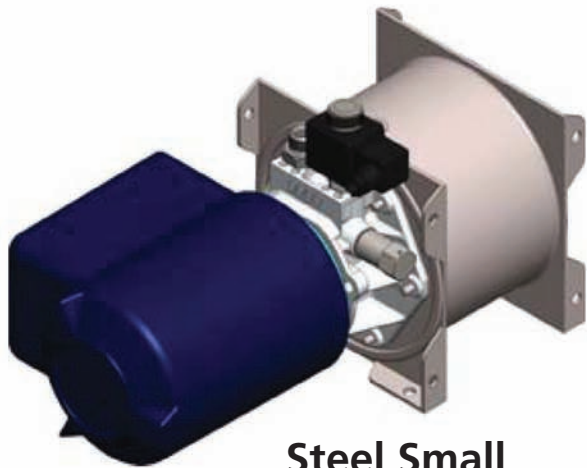



**Steel Small**



**Steel**

**Single Acting**

LTR	Displacement	12v 2000w	24v 3000w
5	2	14741605208	14742305209
7	3.1	14741407315	14742107316
15	3.1	1474145315	14742115316
20	3.1	14741420318	14742120319

**Double Acting**

LTR	Displacement	12v 2000w	24v 3000w
7	3.1	-	14744207311
15	3.1	-	14744215311

For double-acting power packs please use the following part numbers to include the CTOP and hydraulic valve.

- OMFB147424V7L      7 Litre Tank
- OMFB147424V15L    15 Litre Tank



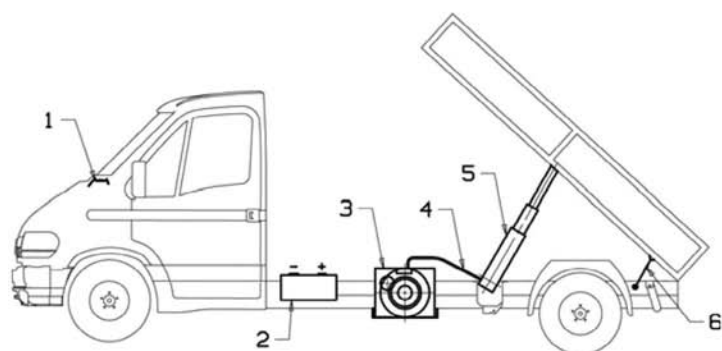

**WORKING CONDITION**

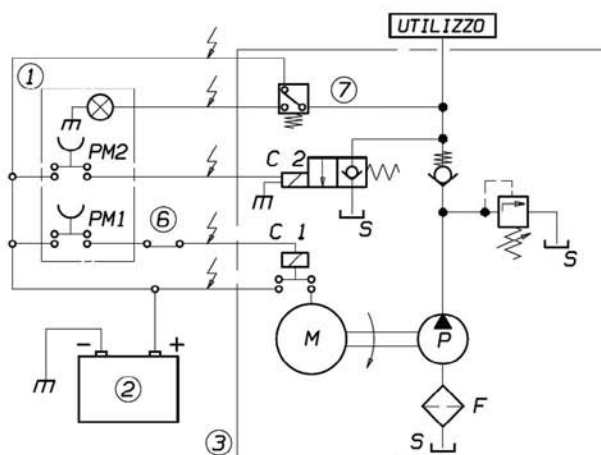

**Motor-remote control switch connection diagram**

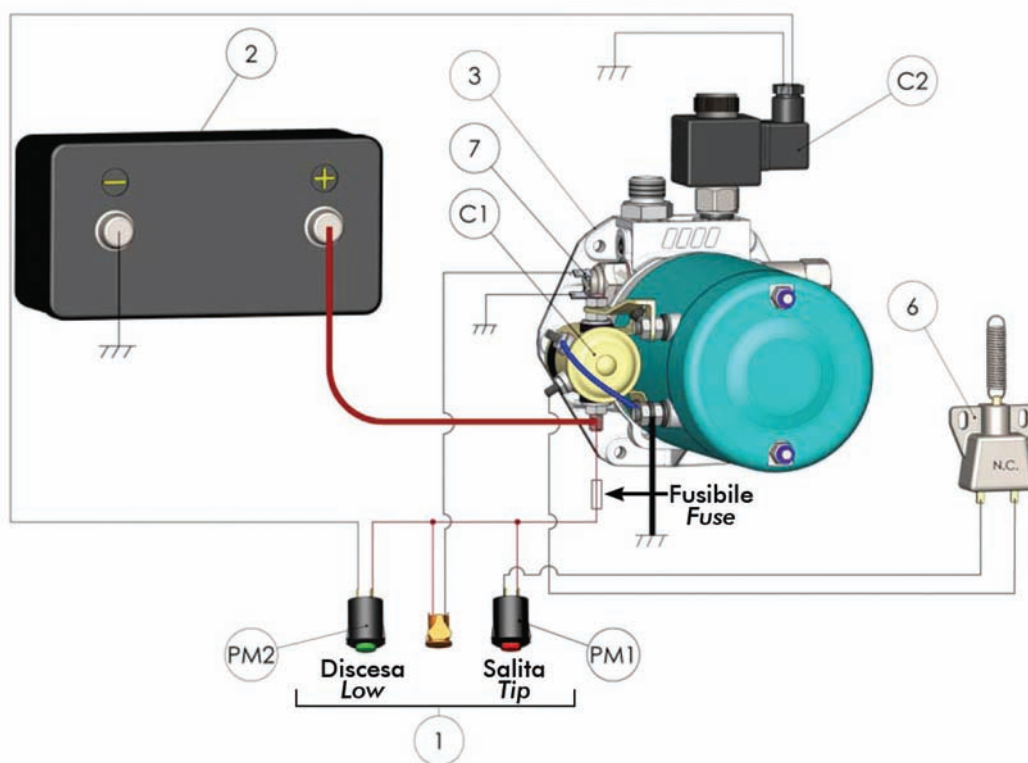

The section must be  $\geq di 35 \text{ mm}^2$  ( $L = < 10\text{mt}$ )





NB: all grounds are intended connected to  $\ominus$  of the battery.

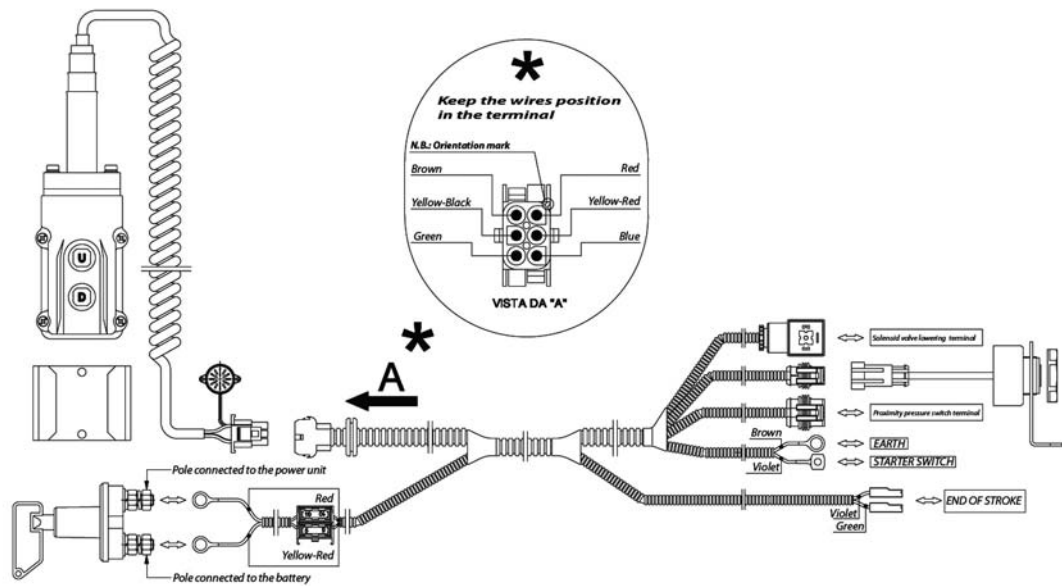

**302-001-00151:**

Long 5000 mm wiring mobile push button control panel PK-RE electric kit with acoustic signal.

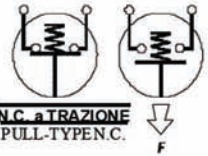

Code	Description	Picture
<b>121-051-00039</b>	<i>Limit switch group normally closed</i>	<b>NC</b> 
<b>149-150-00086</b>	<i>Electric pull-type limit switch, normally open</i>	<b>NA</b> 
<b>149-150-00102</b>	<i>Electric pull-type limit switch, normally closed</i>	<b>NC</b>   N.C. a TRAZIONE PULL-TYPE N.C. F
<b>149-155-00027</b>	<i>Complete PK-RE button panel</i>	
<b>149-155-00054</b>	<i>PA double contact button panel: 2 buttons PK-RE</i>	
<b>321-000-00107</b>	<i>Complete PK-RE button panel</i>	